



# Instructions

## Thermostat MTD3 *English*

**TABLE OF CONTENTS**

1	Technical Specifications.....	3
2	Box Content .....	4
3	Important Safety Instructions.....	6
4	Installing the Sensor .....	8
5	Placement of the Thermostat.....	10
6	Preparing the Thermostat for Mounting.....	12
7	Connections.....	14
8	Mounting the Thermostat.....	16
9	Using the Thermostat.....	18
10	Menu Structure .....	20
11	Error Codes .....	21

OJ Electronics A/S hereby declares that the product conforms with the following directives of the European Parliament:

LVD - Low Voltage Directive

EMC - Electromagnetic Compatibility

RoHS - Restriction of the Use of Certain Hazardous Substances

WEEE - Waste Electrical and Electronic Equipment

**Applicable standards:**

CE: EN 60730-1, EN 60730-2-9



This thermostat can be used as a controller for electric room heating pursuant to EN 50559.

## 1. TECHNICAL SPECIFICATIONS

Control pollution degree.....	2
Software class.....	A
Built-in circuit breaker.....	2-pole, 16 A
Enclosure rating.....	IP 21
Overvoltage category.....	III
Rated impulse voltage.....	4 kV
Ball pressure temperature (TB).....	125°C
Voltage.....	230 V AC $\pm$ 10%, 50 Hz
Max. prefuse.....	16 A
Output.....	Max. 16 A
Output relay.....	Make contact - SPST - NO
Output applications.....	Resistive load 16 A Inductive load 1 A
Terminal wire size.....	$\leq$ 13 A - 1.5 mm <sup>2</sup> , > 13 A to 16 A - 2.5 mm <sup>2</sup> , solid core wire
Method of mounting.....	Flush mounting
Dimensions.....	84 mm x 84 mm
Build-in depth.....	20 mm
Sensor type.....	NTC 12 k $\Omega$ @ 25°C
Max. sensor extension.....	10 m
Temperature range.....	+0/+40°C
Control principle.....	ON/OFF
Purpose of control.....	Thermostat for electric underfloor heating
Design of control.....	PWM/PI
Type of action.....	1.B
Standby power.....	< 0.5 W
Display.....	Segment

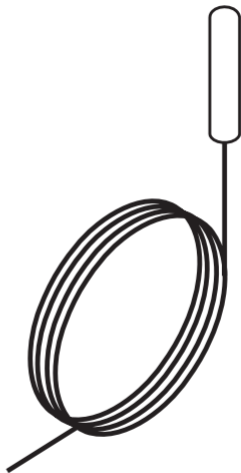
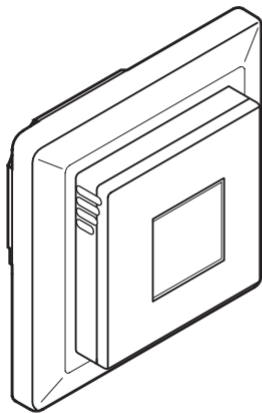

BR1033A01 a

## **2. BOX CONTENT**

- Thermostat
- Floor sensor

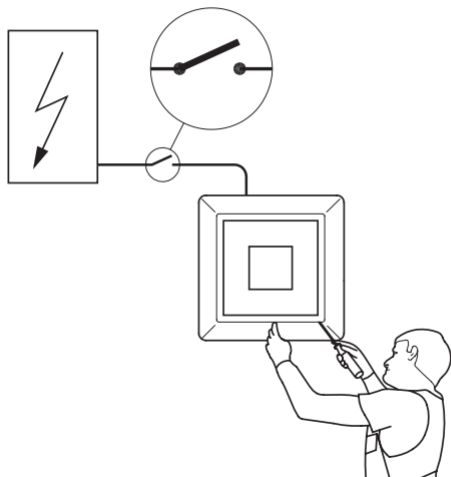

BR1033A02a

### 3. IMPORTANT SAFETY INSTRUCTIONS

**Warning:**

- To avoid electric shock, disconnect the heating system power supply at the main panel before carrying out any work on this thermostat and associated components.
- Protection against electric shock must be guaranteed by appropriate mounting. The requirements of Class II are fulfilled after appropriate mounting (reinforced insulation).
- Installation must be carried out by qualified personnel in accordance with appropriate statutory regulations (where required by law).
- Installation must comply with national and/or local electrical codes.

**Caution:**

- These instructions must be observed, otherwise the liability of the manufacturer shall be voided.
- Any changes or modifications made to this thermostat shall void the liability of the manufacturer.
- Maximum product lifetime is achieved if the product is not turned off - but rather set at the lowest possible setpoint / frost protection when heat is not required.

**Notice:**

- The language used in the original documentation is English. Other language versions are a translation of the original documentation.
- OJ Electronics cannot be held liable for any errors in the documentation. OJ Electronics reserves the right to make alterations without prior notice.

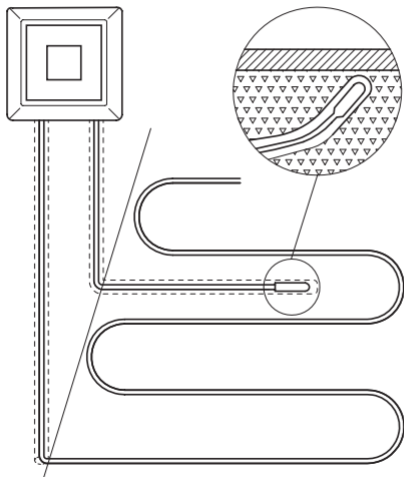

BR1033A05a



#### **4. INSTALLING THE SENSOR**

- Insert the cable and sensor into a non-conductive conduit embedded in the floor.
- The end of the conduit must be sealed and the conduit placed as high as possible in the concrete layer.
- The floor sensor must be centred between loops of heating cable.
- The sensor cable may be extended with additional two-core cable (max. sensor extension, see Technical Specifications).
- The two wires from the sensor to the thermostat must be kept separate from high-voltage wires/cables. Place the sensor cable in a separate conduit or segregate it from power cables in some other way. Ensure that the insulation on both electrical wiring and floor sensor inside the junction box are not damaged. Never use two vacant wires in a multi-core cable.

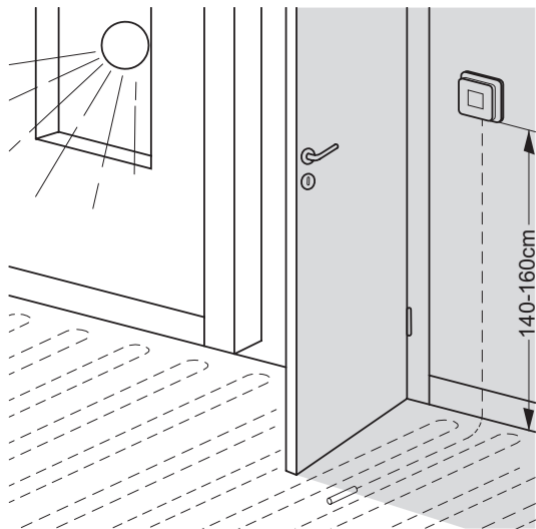

BR1033A04a

## **5. PLACEMENT OF THE THERMOSTAT**

- The thermostat must be mounted on the wall 1.4 - 1.6 m above the floor in such a way as to allow free air circulation around it.  
Draughts and direct sunlight or other heat sources must be avoided.

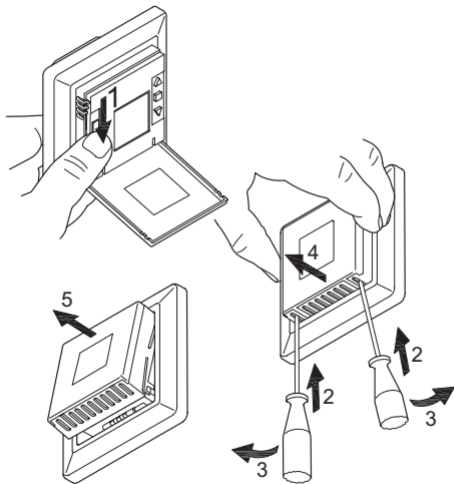

BR1036A03a2

## 6. PREPARING THE THERMOSTAT FOR MOUNTING

- Switch off the thermostat
- Grasp the thermostat with one hand, holding the (closed) front with your thumb on one side and your index and middle finger on the other side. The bottom of the thermostat should be facing you.
- Insert a small screwdriver into the hole to the right, in the bottom of the thermostat.
- Turn the handle of the screwdriver outwards while gently pulling the right side of the bottom a few millimetres towards you.
- Insert the small screwdriver into the hole to the left, in the bottom of the thermostat.
- Turn the handle of the screwdriver outwards while gently pulling the left side of the bottom a few millimetres towards you.
- When the bottom side of the front is loose, pull the front gently away from the back part.

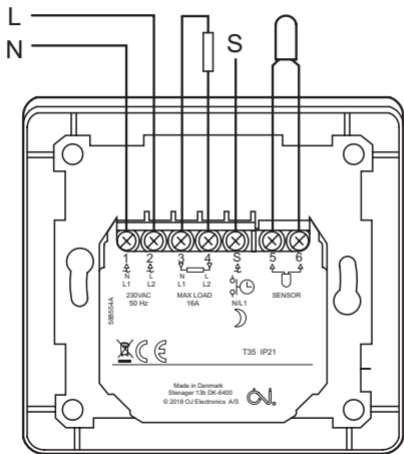

BR1033A16

## 7. CONNECTIONS

Ensure that the mains and load cables are connected as shown in the figure.

Terminal 1: Phase: (N / L1)

Terminal 2: Neutral: (L / L2)

Terminal 3: Load: (N / L1) Resistive load only

Terminal 4: Load: (L / L2) Resistive load only

Terminal S: Night setback (full-wave) / Frost protection (half-wave)

Terminal 5: Sensor (no polarity)

Terminal 6: Sensor (no polarity)

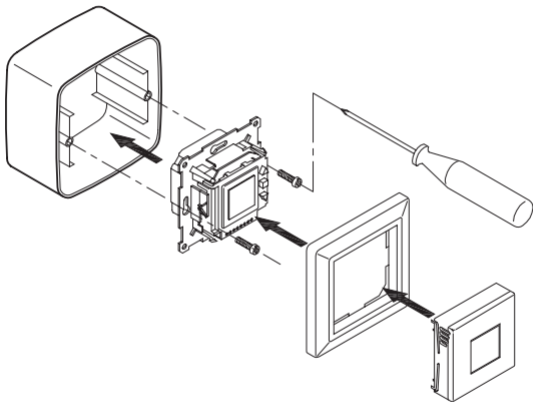

BR1033A07a



## 8. MOUNTING THE THERMOSTAT

- Mount the thermostat in the wall socket.
- Fit the frame and carefully press the cover onto the thermostat - starting with the upper part of the cover, then the lower part of the cover.
- Ensure that both the power slide button on the cover and the power switch pin in the thermostat are down.
- Click the cover into place by applying light, even pressure.  
Warning! Do not apply pressure to the display itself.
- DO NOT attempt to open the thermostat.



<http://downloads.mythermostat.info/7C1jRQIM>

## **9. USING THE THERMOSTAT**

- Open the lid on the front of the thermostat (flip down), slide the ON/OFF switch from “O” to “I”.
- Use the middle button to enter the menu and accept selections.
- Use the arrow up/down to scroll through the menu and toggle between different options in the submenus.

You can find the full user manual by scanning the QR code on the opposite side or entering the URL in a browser.

**10. MENU STRUCTURE**

(Options available may vary depending on version)

<b>Menu</b>	<b>Setting Options</b>	
APP	APP: A; F; C; AF; AE	
SCA	SChI: SCLo - 40.0°C SCLo: 0.0°C - SChI	
Li	LiHi: LiLo - 40°C LiLo: 0°C - LiHi	
tP	FLo: Actual measured temperature ro: Actual measured temperature	
LCd	SCA: C; nu diS: SP; tP	
AdJ	Measured temperature +/- 10°C	
nSb	2.0°C - 8.0°C	
dEF	5.0° - 10.0°C	
PWM	oFF; AUt; On	
	oFF:	diF: 0.3-10.0
	on	CYC: 15-60
	AUt:	CYHi: 10-60 CYLo: 10-30
Pli	0-30 min	
TiMe	ModE: oFF; 5:2; 6:1; 7:0; 0:7 dAY: Non; tuE; UEd; thu; Fri; SAT; Sun hour: 0-23; Min: 0-59	
SW	None	
DonE	Save settings and exit the menu	

## 11. ERROR CODES

E0: Internal fault. Heating is shut off.

E1: Built-in sensor fault.

The sensor application is changed to C (regulator).

E2: Externally wired floor sensor or externally wired room sensor fault.  
(The sensor is either damaged, or has short-circuited or disconnected).

The sensor application is changed to C (regulator)

If AF is used - the sensor application is changed to A (internal room sensor).

E5: Internal overheating.

Internal overheating. If the E5 error persists, please contact your installer.

### Environment and recycling

Please help us protect the environment by disposing of the packaging in accordance with national regulations for waste processing.

### Recycling of obsolete appliances



Appliances with this label must not be disposed of with general household waste. They must be collected separately and disposed of in compliance with local regulations.



